

AQUAPIX®

W3048 EDGE



USER MANUAL

FR : Un manuel dans votre langue est disponible sur Internet:

IT: Il manuale nella sua lingua può essere trovato su Internet:

ES: Puede encontrar un manual en su idioma en Internet:

PT: Um manual em seu idioma pode ser encontrado na Internet:

PL: Instrukcję w swoim języku możesz znaleźć na stronie:

SWE: En handbok på ditt språk finns på Internet:

NL: Een handleiding in uw taal vindt u op internet:

www.easypix.info/download-manuals/download/w3048/

Table of content

Retaining instructions	3
Explanation of safety warnings	3
Product introduction	4
Intended use	4
Restrictions	5
Safety instructions.....	5
Operating environment.....	7
Using your camera.....	8
Description of the product	9
First steps: Preparing your camera for first use	10
1. Battery and memory card installation.....	10
2. Charging the battery	11
3. Format your memory card	12
Camera functions	13
Photo mode	14
Video mode.....	15
Playback mode	16
Deleting files	17
Switch between the two displays.....	18
Transferring files from camera to computer	19
Troubleshooting	21
Cleaning	22
Box contents.....	22
Technical specifications	23
Disposal.....	24
Declaration of conformity	25

Disclaimer

Easypix makes no representations or warranties with respect to this manual and, to the maximum extent permitted by law, expressly limits its liability for breach of any warranty that may be implied to the replacement of this manual with another. Furthermore, Easypix reserves the right to revise this publication at any time without incurring an obligation to notify any person of the revision. Easypix is not responsible or liable for misuse of the information that is contained herein. If you have any suggestions for improvements or amendments or have found errors in this publication, please notify us. All pertinent state, regional, and local safety regulations must be observed when installing and using this product. For reasons of safety and to help ensure compliance with documented system data, only the manufacturer shall perform repairs to components. Failure to observe this information can result in injury or equipment damage. Copyright © by Easypix GmbH

All rights reserved. No part of this publication may be reproduced, distributed, or transmitted in any form or by any means, including photocopying, recording, or other electronic or mechanical methods, without the prior written permission of the publisher. For permission requests, please write to the publisher below.

Easypix GmbH, Em Parkveedel 11, 50733 Köln, Germany.
support@easypix.eu • www.easypix.eu

Retaining instructions

Read this manual and its safety instructions before using this product.

Follow all the instructions. This will avoid fire, explosions, electric shocks or other hazards that may result in damage to property and/or severe or fatal injuries.

The product shall only be used by persons who have fully read and understand the contents of this user manual.

Ensure that each person who uses the product has read these warnings and instructions and follows them.

Keep all safety information and instructions for future reference and pass them on to subsequent users of the product.

The manufacturer is not liable for cases of material damage or personal injury caused by incorrect handling or non-compliance with the safety instructions.

Explanation of safety warnings



WARNING

Warning indicates a hazard with a medium level of risk which, if not avoided, could result in serious injury.

NOTICE

Indicates information considered important, but not hazard-related.

Product introduction

The Aquapix W3048 'Edge' is a high quality digital still and video camera.

Waterproof to 3M and featuring a 13MP sensor, it captures photos up to 48MP resolution and full high definition video up to 4K.

Powered by rechargeable battery, W3048 'Edge' utilizes 2 full colour displays and 16x digital zoom to ensure your selfies, photos and videos are framed and captured perfectly.

Intended use

This product is intended for use anywhere selfies, photos or videos are taken.

It's 3m waterproof rating means it can also be completely submerged and used under water.

NOTICE

WATERPROOF AND DUSTPROOF PERFORMANCE

The waterproof and dustproof performance described do not guarantee that the camera will remain completely waterproof or free from damage and trouble under all conditions.

Do not subject the camera to excessive shock, vibration or pressure by dropping it, hitting it or placing a heavy object on it.

Failure to observe this precaution could deform the camera, cause water to seep inside, or damage the airtight seals, resulting in camera malfunction.

Restrictions



WARNING

The product is not suitable for children under 3 years because of choking hazard.

- Contains small parts, in order to avoid swallowing, please ensure any use by children is undertaken with adult supervision.
- The camera is suitable for use underwater to a maximum depth of 3 metres. Do not use the camera at depths exceeding 3 metres.
- Do not use your camera in hot springs, hot tubs or jacuzzis where it can be exposed to extreme water temperature.

Safety instructions



WARNING

This product is only suitable for the purpose described, the manufacturer is not liable for damage caused by abnormal use.



WARNING

Please read this instruction manual carefully before use, and ensure the batteries are installed correctly.

- Do not leave the camera in a high or low temperature environment for a prolonged period of time.
- Keep the camera out of the reach of small children.
- No special maintenance is required during use.

Please contact the seller or manufacturer if your device displays a fault.

- Please dispose of the waste and residues at the end of the service life of the product according to local laws and regulations.



WARNING

- If you think this product is damaged in any way, please do not use the product.
- Do not open this product without permission.
- Contains small parts, in order to avoid swallowing, please ensure any use by children is undertaken with adult supervision.



WARNING

BATTERY

- Use only rechargeable batteries approved for use with this product
- Do not short-circuit the battery terminals.
- Avoid battery terminal contact with jewellery, hairpins or other metal objects.
- The battery should only be recharged in the camera.
- Insert the battery and memory card before using the camera underwater. Take care to ensure that all flaps and covers are closed and that no water can penetrate the camera. If this happens, turn off the camera and do not use it underwater.
- Never open the battery compartment under water. If moisture appears on the lens during use, it may be leaking. Remove the battery and the memory card and return the camera to your dealer for repair.
- Please remove the battery if the camera is not going to be used for an extended period of time.



WARNING

- To avoid the risk of electric shock, do not insert the power cord with wet hands. The battery compartment should only be opened with clean, dry hands to also ensure that no dirt enters the camera when inserting, changing or removing the batteries or SD card.
- In order to prevent product damage or negatively affecting the sound or image quality, please ensure a sufficient distance is maintained from objects that generate strong magnetic fields or radio waves, such as electrical appliances.
- In the unlikely event of overheating, smokes or unpleasant odors coming from the unit, disconnect it immediately from the charging cable and remove the battery to avoid a fire.

Operating environment

- Do not expose the device to abnormally high or low temperatures.
- Store the device cool (at room temperature) in a dry and dust-free location and never expose the product to high temperatures or direct sunlight.
- Always protect your camera from falls, shock and impact.

Using your camera

As your camera is waterproof, it can be used under water while playing and swimming etc.

To prevent it from sinking or getting lost in the water, you can attach the included wrist strap to the camera before entering the water.

To prevent damage please ensure that you do not open the camera while in the water.

After use in swimming pool water or sea or lake salt water, please rinse it with clean tap water and wipe dry before opening the battery compartment.

The cameras default settings are optimised for most circumstances enabling you to take photos or videos immediately after inserting a memory card and switching it on.

Description of the product

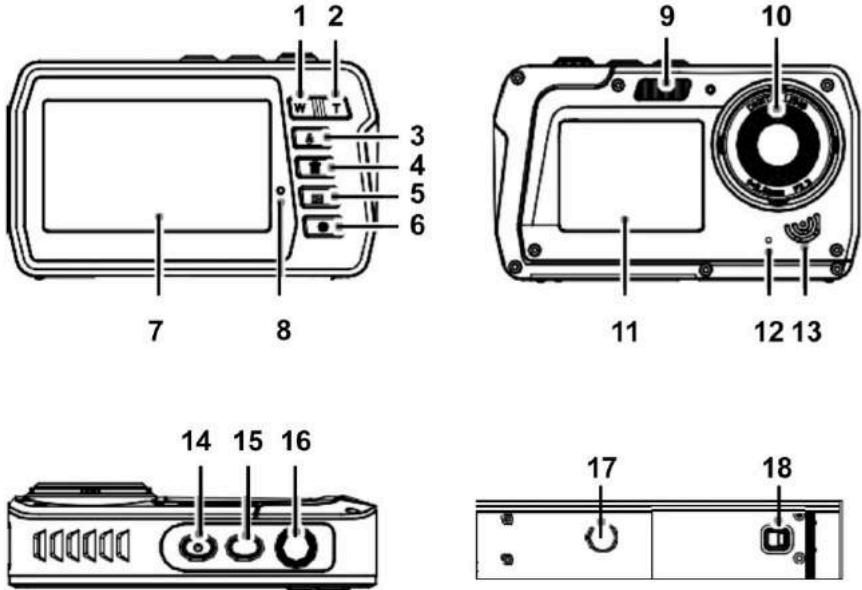

- 1. Zoom Out / Left button (W)
- 2. Zoom In / Right button (T)
- 3. Flash / Up button
- 4. Delete / Down button
- 5. Playback / Mode / Return button
- 6. Menu / OK button
- 7. Main Screen
- 8. Indicator LED

- 10. Camera lens
- 11. Front screen for Selfies
- 12. Microphone
- 13. Speaker
- 14. Power button
- 15. Switch between the displays
- 16. Shutter button
- 17. Tripod mount
- 18. Battery compartment

First steps: Preparing your camera for first use

NOTICE

Opening and Closing the battery compartment:

Always ensure the camera and your hands are dry.
Ensure that there is no debris inside the battery-

chamber or memory card slot.

Always ensure that the battery cover is firmly closed and the security lock is in the lock position before using the camera.

1. Battery and memory card installation

- Move the Lock/Unlock Switch on the battery cover to the unlock position and open the battery cover by sliding it in the direction of the arrow - see Fig 1.
- Insert the battery ensuring correct polarity and pin alignment - see Fig 2.
- Insert the memory card as indicated – see Fig 3.
- Push the Micro SD card until you hear a slight clicking sound, which confirms the SD card is correctly installed.
- Close the battery cover and push the Lock/Unlock switch to the Lock position.

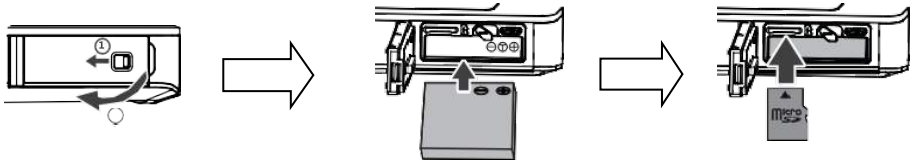

Fig 1

Fig 2

Fig 3

NOTICE



Batteries and electronic equipment should be disposed of in accordance with applicable local regulations, and you should not throw them into household garbage to avoid irreversible pollution.

2. Charging the battery

- Open the battery compartment door and connect the camera to a USB AC adaptor using the Micro USB cable provided.
- Connect the AC Adaptor to a power outlet.

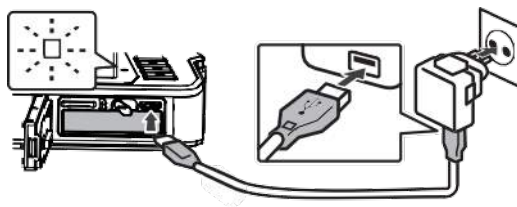

- The indicator LED confirms the battery is charging.
- The charging process is complete when the LED indicator turns off.
- Disconnect the charging cable from the camera and close the battery compartment door ensuring you push the Lock/Unlock button to the Lock position.

3. Format your memory card

NOTICE

To ensure the optimal functioning of your camera, please note the following important information:

- Before using any micro SD card in your camera for the first time, please ensure your memory card is formatted in the camera. This option can be found in the camera's settings menu:
Menu > Format Memory Card
- The maximum memory card capacity supported is 128 GB. Use of memory cards exceeding the maximum recommended capacity may result in file errors.
- The recording time varies depending on the resolution selected.
- Memory cards with a speed class rating of 6 or faster are recommended for recording videos. When using a memory card with a lower speed class rating, video recording may stop unexpectedly.

Camera functions

When you turn on the camera for the first time, screens for setting the menu language and camera time and date are displayed.

LANGUAGE SETTING

- Press the power button to turn the camera on
- Press the Menu button and use the Left (W) and Right(T) buttons to select the **Language** settings screen.
- Use the Up and Down buttons to select your preferred language and confirm your setting By pressing the OK button



DATE AND TIME SETTING

- Press the Left (W) and Right(T) buttons to select the Time and Date settings screen.
- Use the Up and Down buttons to select **Date/Time Setup** and press OK
- Use the Left and Right buttons to select the field to be changed and use the Up and Down buttons to set the date and time.
- Press OK to confirm the settings.



Select Date/Time **On** to show the date and time on the display.

Select Date/Time **Off** to conceal it.

Photo mode

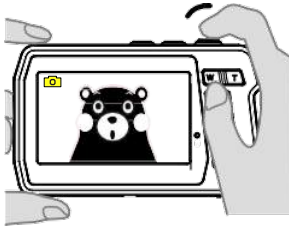

Fig 1



Fig 2

- After switching on, the camera will be in photo mode and ready to take photos, as indicated by the photo icon on screen – See Fig 1.
- Hold the camera steady and use the display to frame your photo.
- Use the W button to capture a wider image or the T button to zoom in and capture a larger subject – See Fig 2
- Press the shutter button to capture your image.
- If you want to change settings in photo mode, press the Menu/OK button.
There you can change the photo settings as you like.
Press the Mode button to go back to the Photo mode.

Video mode

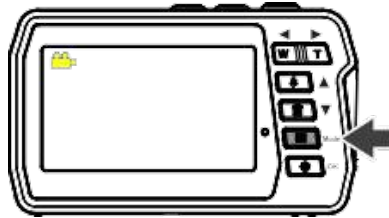

- Press the Mode button to select the Video mode.
- Press the shutter button to start recording a video.
- Press the shutter button again to stop recording.
- If you want to change settings in video mode, press the Menu/OK button.
There you can change the video settings as you like.
Press the Mode button to go back to the Video mode.

NOTICE

4GB MAX. MOVIE SIZE:

Individual movie files cannot exceed **4 GB** in size, even when there is sufficient free space on the memory card for longer recordings. The remaining recording time for a single movie is displayed on the display screen.

Micro SD (TF) memory cards with a Speed Class rating of 6 or faster are recommended when recording video. Video recording may stop unexpectedly if a memory card with a lower Speed Class rating is used.

Playback mode

- Press repeatedly the Mode button to enter Playback mode.
- Use the Up and Down buttons to scroll through your photos and videos:
 - Up – Previous image
 - Down – Next image
- Press the Shutter button to Play and Pause videos.
- Alternatively you can view your images and videos on your computer.
(See how to **transfer files from camera to computer** below.)

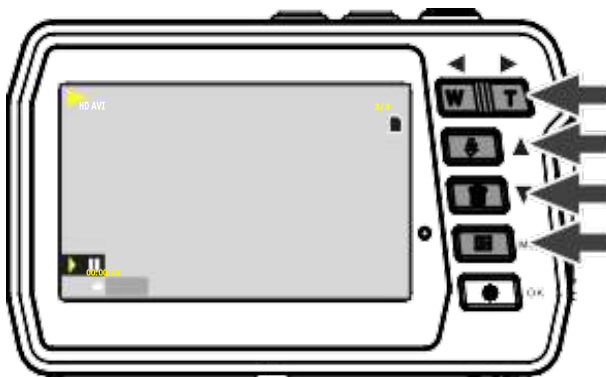

Deleting files

In the Playback mode:

- Find an image or video you want to delete.
- Press the Menu/OK button.
- Use the up and down buttons to choose to delete a single file, delete all files or cancel.
- Press OK to confirm your selection.
- Choose YES / NO to complete or abort the process.



NOTICE

It is also possible to delete the last photo or video recorded while you are in Photo or Video mode:

- While you are in Photo or Video mode simply press the Delete button to enter the delete option.
- Select YES to delete the file or NO to abort.

Switch between the two displays

The camera has two screens:

A main screen on the back and a front screen on the front.

The big main screen gives you a large overview of your photo and video recordings and all functions of your camera.

The front screen is perfect for your selfie shots.

For example, you can take photos and videos of yourself underwater and always keep a perfect view of the perfect detail.

Just switch between the displays and see yourself on the front screen.

Switching the displays works simply by pressing the switch button:



Main Screen

3.0"/7.6cm (16:9)



Front Screen for Selfies

2.0"/5.0cm (4:3)

NOTICE

Settings and Playback mode are not available on the front screen. They are only available on main screen on the back of the camera.

Transferring files from camera to computer

NOTICE

Disconnect all other USB-powered devices from the computer. Connecting the camera and other USB-powered devices to the same computer simultaneously may cause a camera malfunction or excessive power supply from the computer, which could damage the camera or memory card.

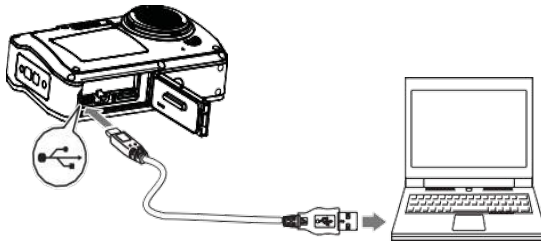

WINDOWS:

1. Use the USB cable that came with your camera to connect your camera to your computer.
2. Turn on the camera.
3. MSDC appears on the TFT screen.
4. A window appears with a list of options. Select “Open folder to view files” and click OK.
5. Open the DCIM folder and the folder inside to view the media files.
6. Select the media and copy the files from this folder into your computer. Alternatively, select the files and choose Copy from the Edit menu. Then select a folder and choose Paste from the Edit menu.
7. Do not disconnect the cable during transfer.
Doing so will cancel the current transfer of any files to your computer.

8. When finished, ensure the camera's connection with Windows is properly terminated before disconnecting the cable.

MAC:

1. Use the USB cable that came with your camera to connect your camera to your computer.
2. Turn on the camera.
3. MSDC appears on the LCD.
4. The camera's device icon appears on the desktop.
5. Click on the device icon and open the DCIM folder and the folder inside to view the media files.
6. Select the files and drag them to your computer. Alternatively, select the files and choose Copy from the Finder's Edit menu. Then select a folder and choose Paste from the Edit menu.
7. We recommend that you copy the images into the Pictures folder and the videos into the Movies folder.
8. Do not disconnect the cable during transfer. Doing so will cancel the current transfer of files to your computer.
9. When finished, ensure the device icon is dragged to the bin before disconnecting the cable.
9. Alternatively, right click and select the 'Eject...' Option

Troubleshooting

If the camera fails to function as expected, please check the list of common problems below before consulting your retailer.

Problem	Cause/Solution
The camera cannot be turned on.	<ul style="list-style-type: none">- The battery is exhausted.- Battery installation error.
The camera turns off without warning.	<ul style="list-style-type: none">- The camera automatically turns off to save power (auto off function).- Camera and battery may not work properly at low temperatures.- The inside of the camera has become hot. Leave the camera off until the inside of the camera has cooled, and then try turning it on again.
The screen is blank.	<ul style="list-style-type: none">- The camera is off.- The camera automatically turns off to save power (auto power off).- The functions are displayed on only one of the two screens. Please check if the other screen is active.
The camera becomes hot.	The camera may become hot when used for an extended period of time such as to shoot movies, or used in a hot environment. This is not a malfunction.

Cleaning

- After use in water, turn off the camera, ensure the battery compartment is tightly closed, and rinse the camera with fresh water within 30 minutes.
- The best cleaning method is to immerse the camera in a basin of fresh water for 10 minutes.

When the camera is immersed in water, air bubbles may be seen coming from the water drain holes of the camera such as openings in the microphone or speakers. This is not a malfunction.

- Do not use soap or detergents, as they could negatively affect the integrity of the waterproof seals on the camera.
- Allow the camera to dry at room temperature after rinsing.

Box contents

- **Camera**
- **Pouch**
- **Hand strap**
- **USB cable**
- **Lithium battery**
- **Manual EN/DE**

Manuals in further languages are available for download at www.easypix.info/download-manuals/download/w3048/

Technical specifications

*by interpolation

Waterproof	Up to 3m
Sensor	13MP CMOS sensor
Photo resolution	48MP* (8000x6000) 30MP* (6400x4800) 24MP* (5600x4200) 20MP* (5200x3900) 16MP* (4608x3456) 12MP (4000x3000) 8MP (3264x2448) 7MHD (3648x2048) 5MP (2592x1944) 3MP (2048x1536) 2MHD (1920x1080)
Movie resolution	4K* (3840x2160) 10fps 2.7K* (2688x1520) 25fps FHD (1920x1080) HD (1280x720)
Dual Display	2.0"/5.0cm (4:3) IPS front screen 3.0"/7.6cm (16:9) IPS main screen
External Memory	Compatible with MicroSD Cards up to 128GB (not included)
Digital Zoom	16x
Scenes	Auto, Scenery, Portrait, Night Scenery, Night Portrait, High Sensitivity, Sport Beach, Party
White Balance	Auto, Daylight, Cloudy, Fluorescent, Incandescent
Color Effects	Standard, Sepia, Monochrome, Vivid

EV	-3, -2, -1, 0, +1, +2, +3
ISO	Auto, 100, 200, 400
Anti-Shake	Support
Face Detect	Support
Multi Snapshots	Support
Self Timer	Off, 2s, 5s, 10s
Sharpness	Soft, Normal, Sharp
Frequency	60HZ, 50HZ
Auto Power Off	1 min / 3 min / 5 min
Interface	Micro USB
Lithium Battery	Rechargeable 1500mAh lithium battery (exchangeable)
Dimensions	110 x 68 x 32mm

Disposal



Dispose of packaging.

For disposal, separate packaging into different types. Cardboard and board must be disposed of as paper and foil must be recycled.



Disposal of Waste Electrical and Electronic Equipment and/or Battery by users in private households in the European Union.

This symbol on the product or on the packaging indicates that this cannot be disposed of as a household waste. You must dispose of your waste equipment and/or battery by handing it over to the applicable take-back scheme for the recycling of electrical and electronic equipment and/or battery. For more

information about recycling of this equipment and/or battery, please contact your city office, the shop where you purchased the equipment or your household waste disposal service. The recycling of materials will help to conserve natural resources and ensure that it is recycled in a manner that protects human health and environment.

Declaration of conformity

For the product **W3048 EDGE** we hereby confirm that it meets the basic requirements laid down in

2014/53/EU

2011/65/EC RoHs

2014/30/EU EMV

2012/19/EC WEEE



The EC Declaration of Conformity can be downloaded here:
http://www.easypix.info/download/pdf/doc_w3048.pdf

EASYPPIX | LIFESTYLE
ELECTRONICS